

Gun nozzles for every application

Different extensions, flat spray, round spray and angle nozzles are designed to offer the best results even with difficult applications.

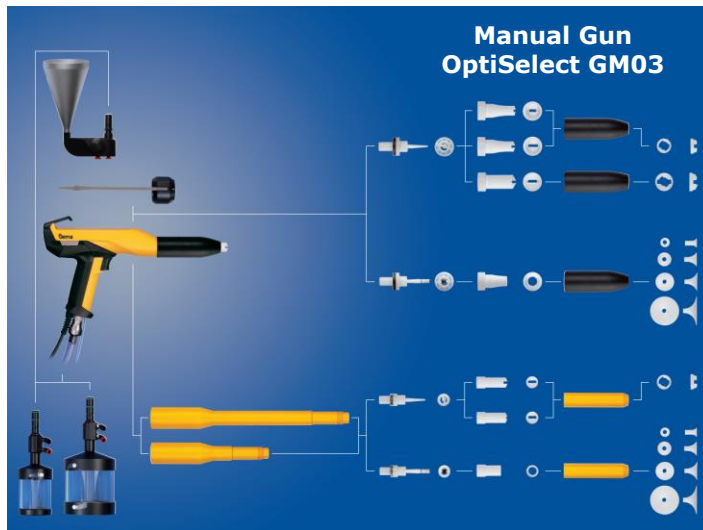

Compliant with **ATEX directive 94/9/EG**

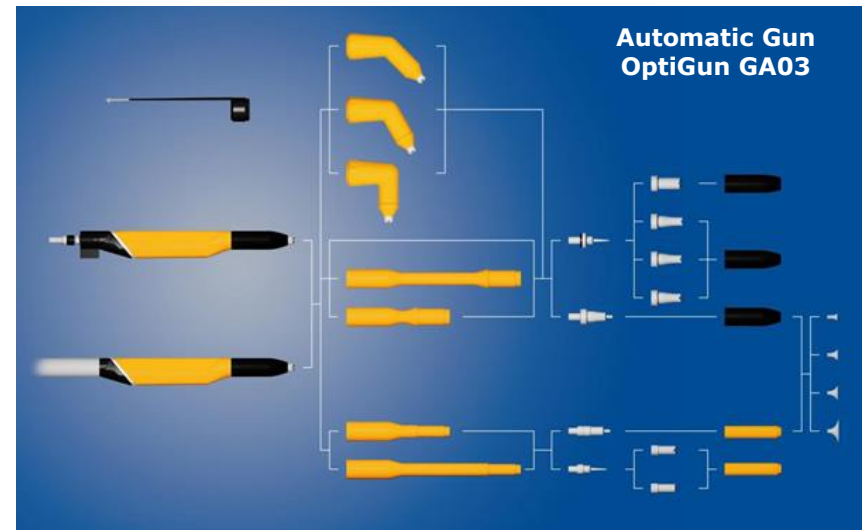

Compliant with **ATEX directive 94/9/EG**

Highest powder
transfer efficiency

Perfect powder
distribution

Consistent
application quality

Overview Nozzle Assortment

Hyperlink on Nozzle Gema No.

→ will lead to nozzle portrait

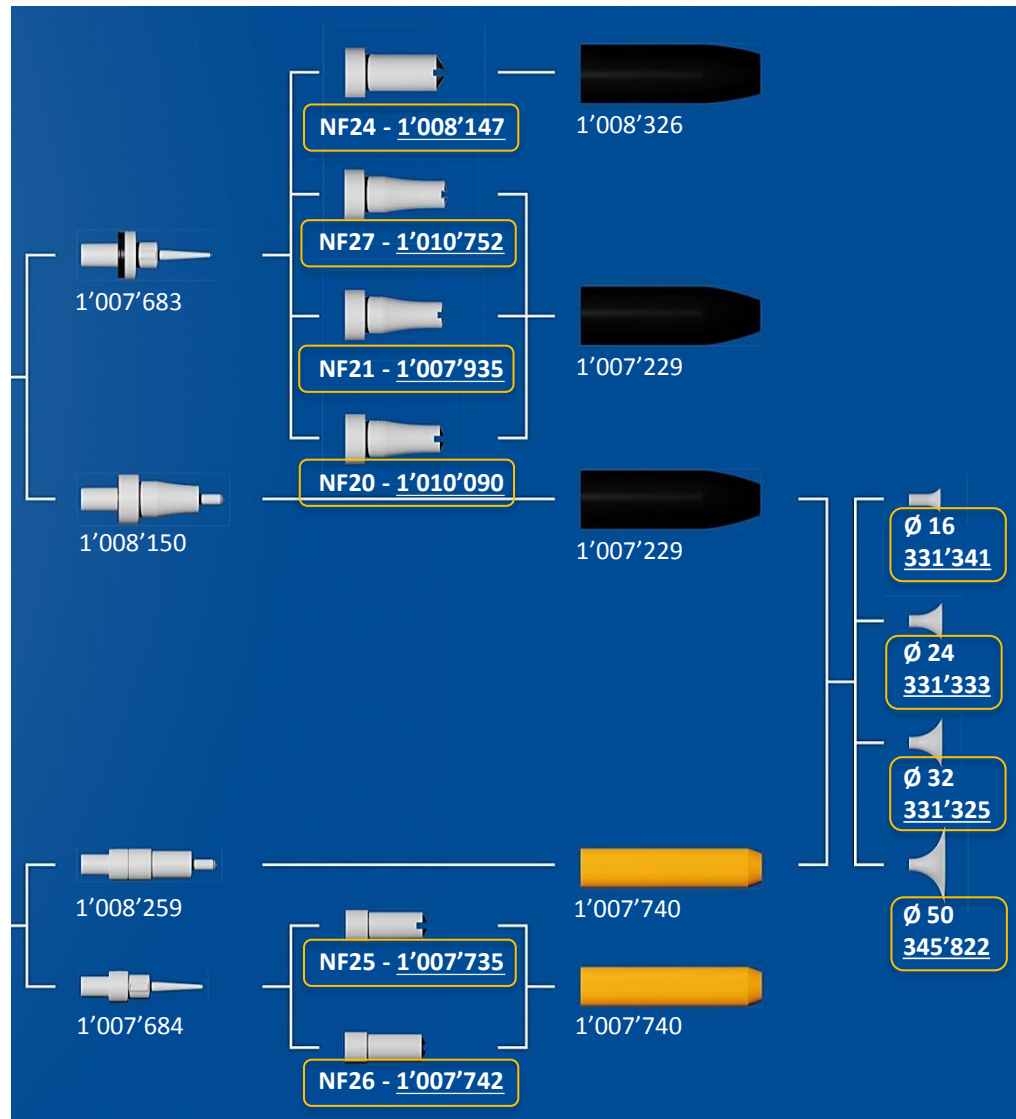

Gun nozzle design

- Powder coating requires a perfect combination of nozzle design and high voltage supply to achieve an homogeneous powder cloud.
- The high voltage field plays a very important role ensuring a perfect powder atomization and charging.
- Different object geometries to be coated require different nozzle geometries to ensure that the powder cloud is ideal and at the right speed.

Effect high voltage on powder cloud

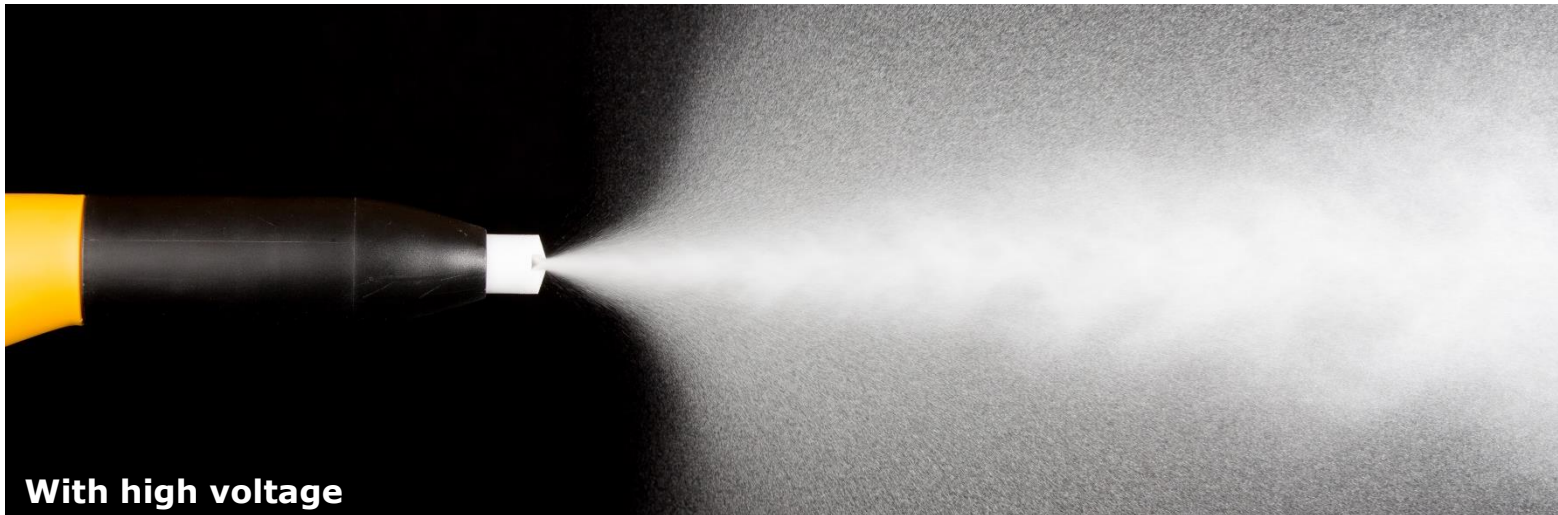

Powder distribution NF27 (close up)



NF27 Homogeneous powder distribution

Gun nozzles and extensions

- The nozzles and extensions are interchangeable for the manual and automatic guns, thanks to the compatible and smart gun shaft design.
- All nozzles and extensions are compliant to the ATEX directives.
- The use of high quality non-stick materials prevents powder accumulations and allows a high quality color change.

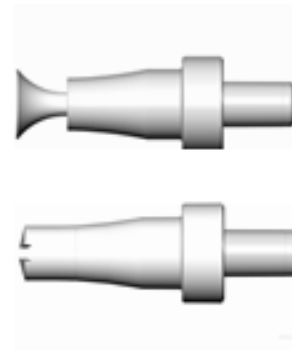

OptiSelect GM03



OptiGun GA03

Extensions for round and flat jet nozzles

- Manual and automatic guns can be provided with robust and solid nozzle extensions of 150 and 300 mm length. These nozzles are interchangeable with the standard nozzles and offer a perfect flexibility of use.
- Special smaller and lighter-weight extensions are also available.
 - In manual applications they offer easy and stress-free operation over a long working time.
 - In automatic application, they are ideal for inside coating of narrow areas like in boilers.

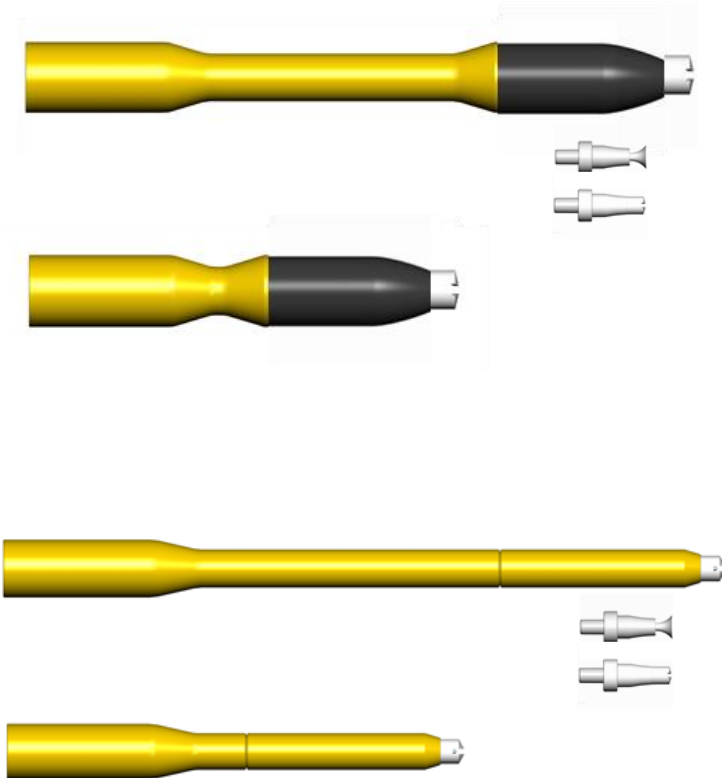

Angle nozzles for special applications

- A wide range of 45°, 60° and 90° angle nozzles are available for challenging applications.
- The typical area of use are complex geometries like profiles, chassis, beam frames and cabinet coating.
- The angle nozzles are also ideal for variety of applications where fixed guns are needed.

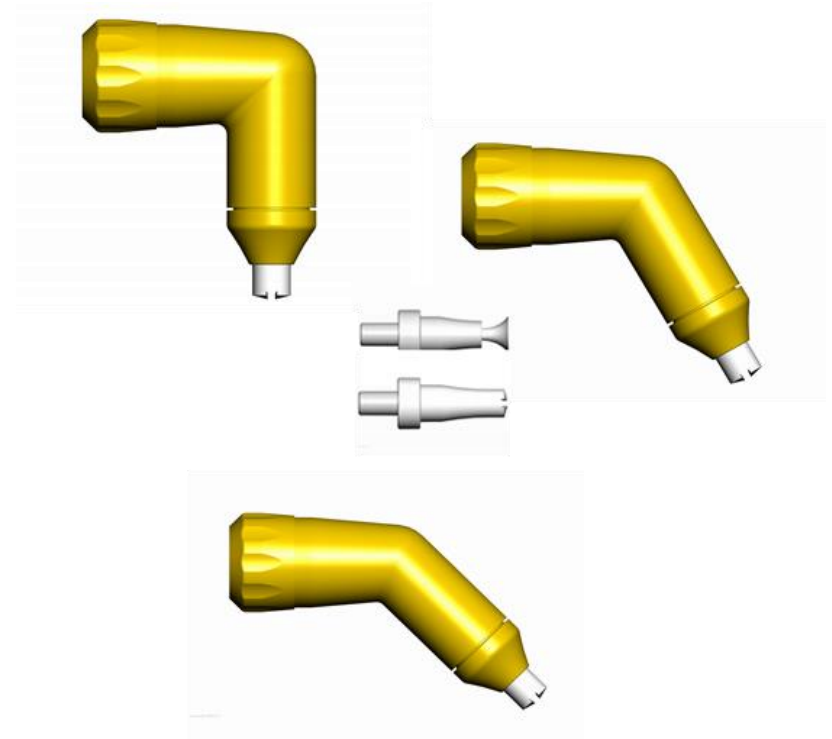

SuperCorona add-on to improve quality

- In a corona gun the high voltage electrode generates a big quantity of air ions
- Only a few air ions really charge the powder particles, the other ions remain free and are attracted by the surface to coat (which is grounded).
- The high accumulation of free ions on the surface to coat can produce an uneven powder layer and the so called “**orange peel effect**” or “**back-ionization**” problems.
- **SuperCorona** discharges the excessive free ions to ground and avoids overcharging of the powder and of the surface to coat.

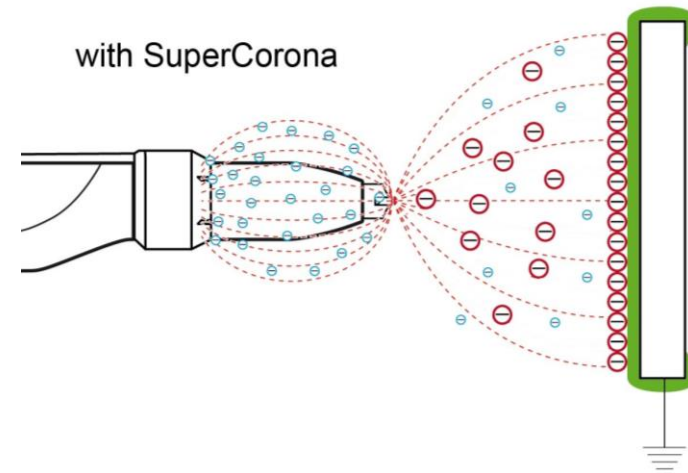
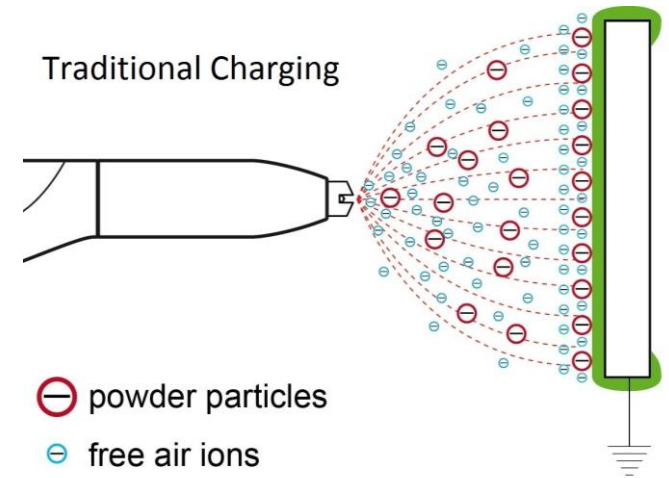

Flat jet nozzle / NF

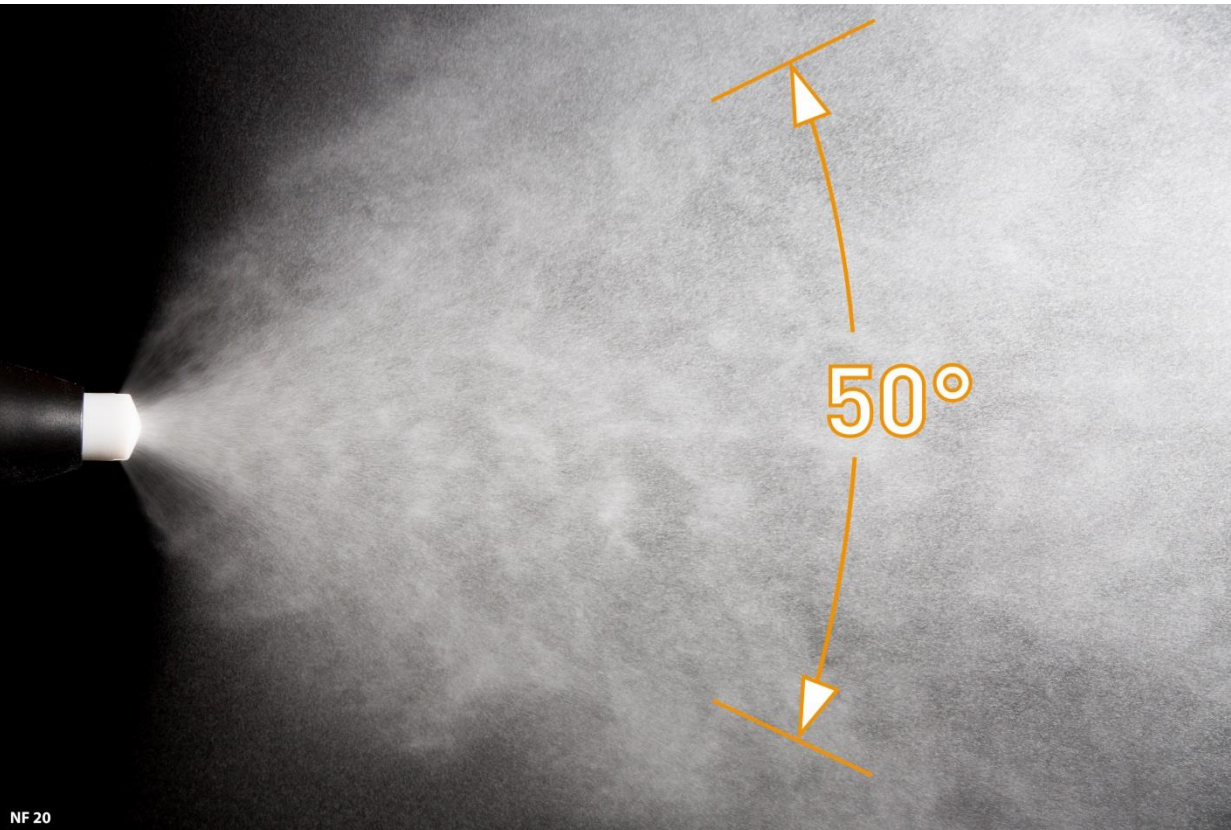

Flat jet nozzle type NF20
Standard for GM03

NF20 complete *with* electrode holder
Gema No. 1'010'160

NF20 *without* electrode holder
Gema No. 1'010'090

Field of application

Standard manual nozzle

- Flat parts
- Profiles

Angle = **50°**

Velocity = **moderate - low**

Distance to object maximal = **250 mm**



Back to overview

Flat jet nozzle / NF

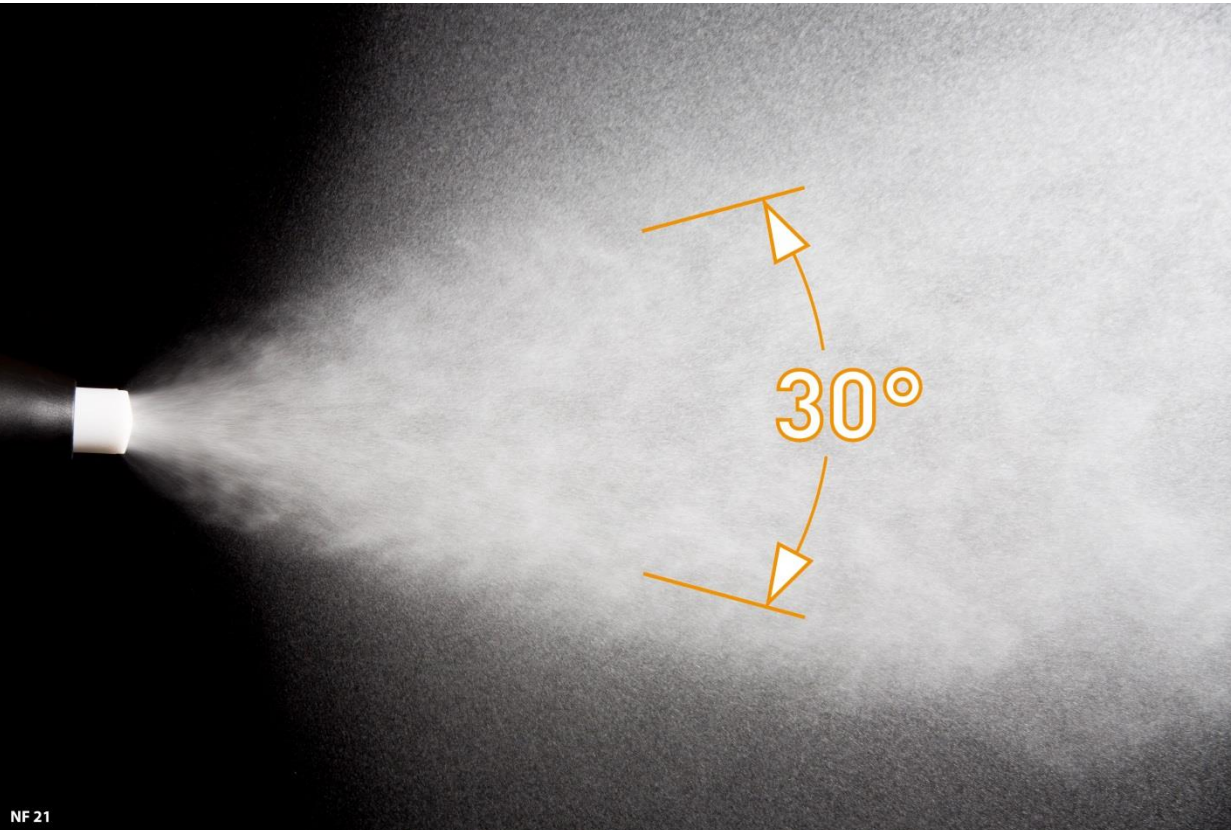

Flat jet nozzle type **NF21**

NF21 complete *with* electrode holder
Gema No. 1'007'932

NF21 *without* electrode holder
Gema No. 1'007'935

Field of application

Automatic & manual nozzle

- Complex parts (deep recess)
- Target spraying

Angle = **30°**

Velocity = **high**

Distance to object maximal = **400 mm**



[Back to overview](#)

Flat jet nozzle / NF

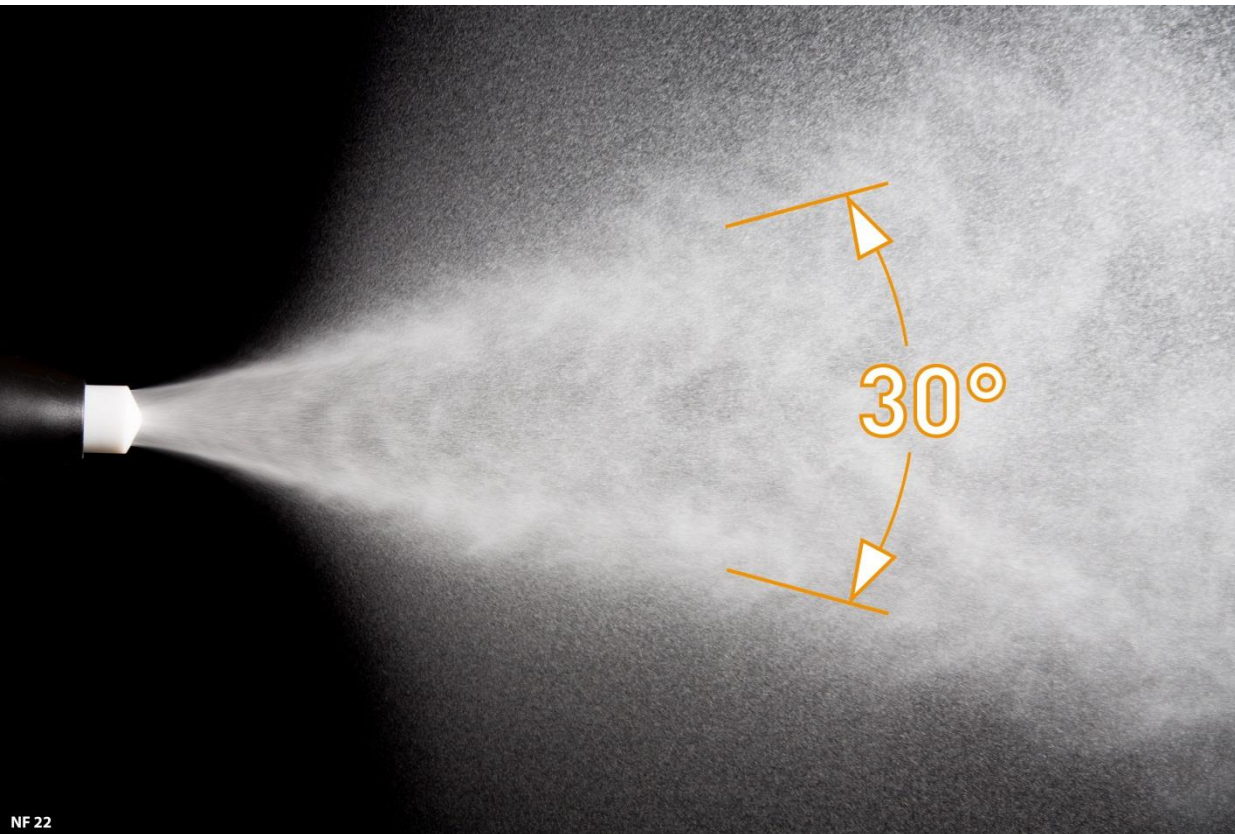

Flat jet nozzle type **NF22**

NF22 complete *with* electrode holder
Gema No. 1'008'140

NF22 *without* electrode holder
Gema No. 1'008'145

Field of application

- Automatic & manual nozzle
- Complex parts (deep recess)
 - Target spraying
 - Robot applications

Angle = **30°**

Velocity = **high**

Distance to object maximal = **450 mm**



[Back to overview](#)

Flat jet nozzle / NF

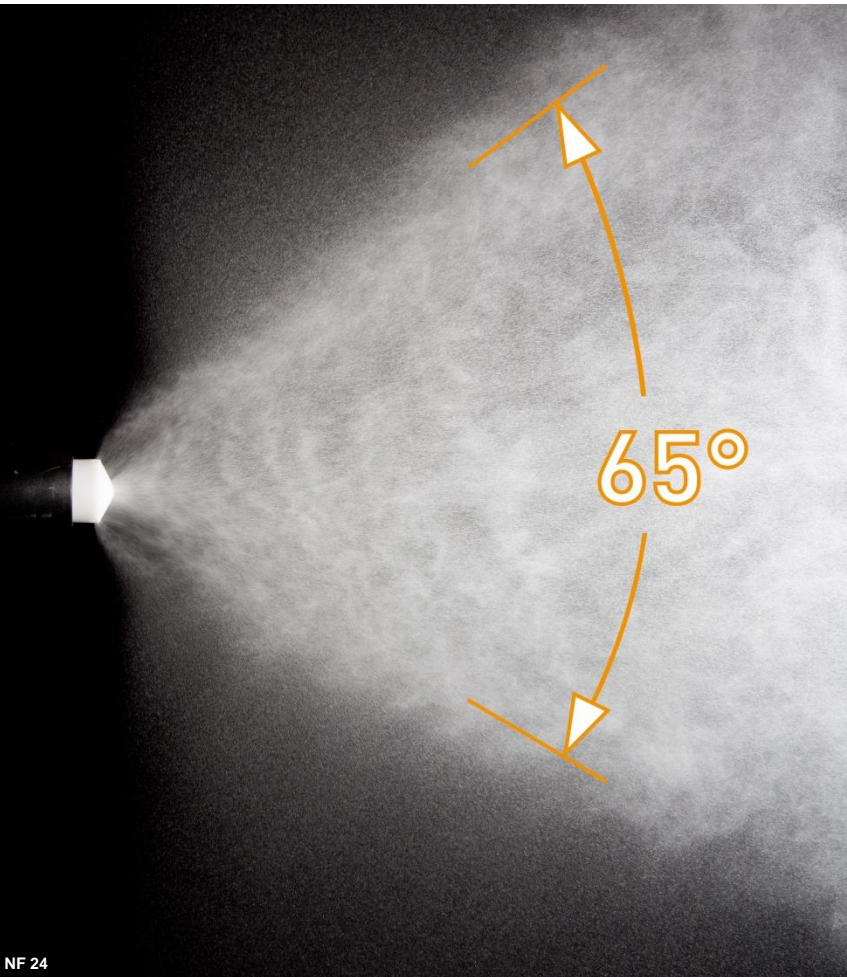

NF 24



[Back to overview](#)

Flat jet nozzle type **NF24**

NF24 complete *with* electrode holder
Gema No. 1'008'142

NF24 *without* electrode holder
Gema No. 1'008'147

Field of application

Automatic & manual nozzle

- Large object
- Flat parts
- Complex parts when nozzle close to the object

Angle = **65°**

Velocity = **low**

Distance to object maximal = **200 mm**

Remark:

In combination with threaded sleeve
Gema No. 1'008'326

Flat jet nozzle / NF

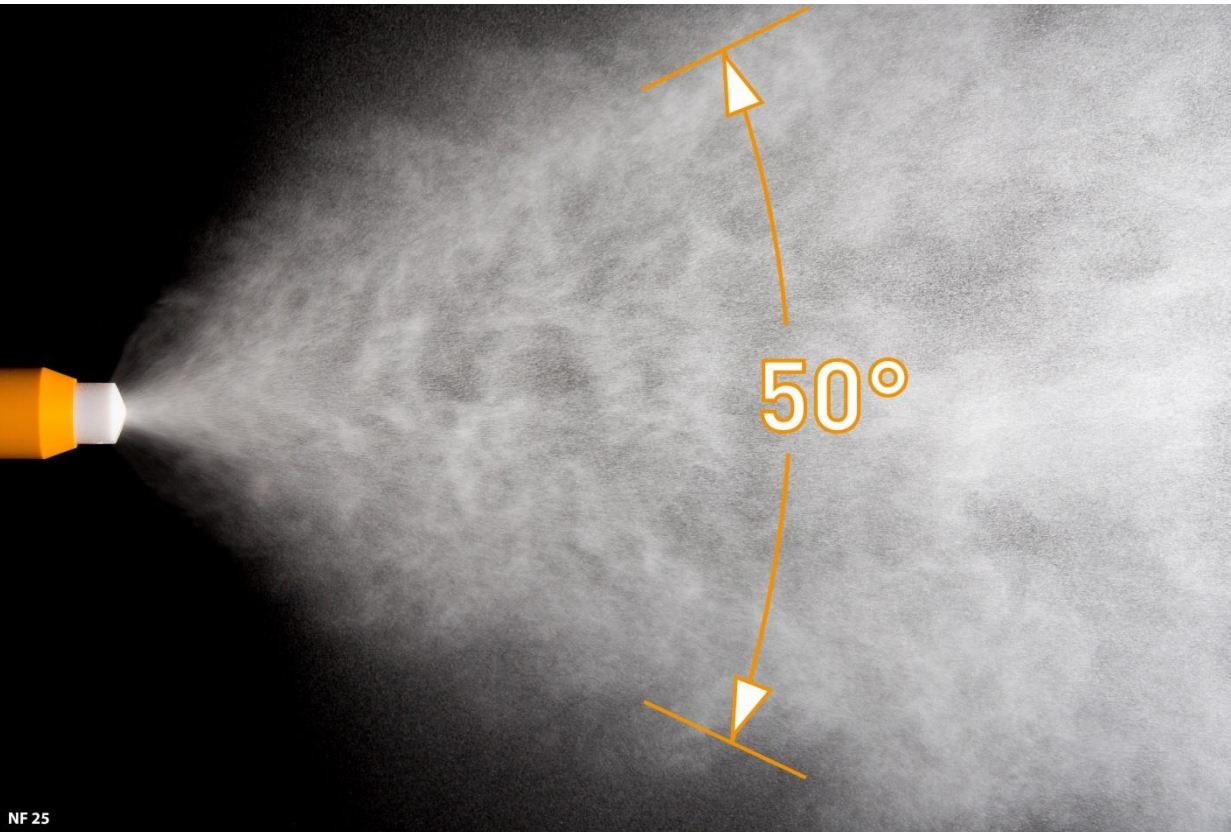

Flat jet nozzle type **NF25** (mini)

NF25 complete *with* electrode holder
Gema No. 1'007'743

NF25 *without* electrode holder
Gema No. 1'007'735

Field of application

Automatic & manual nozzle

- Flat parts
- Profiles

Angle = **50°**

Velocity = **moderate - low**

Distance to object maximal = **250 mm**

Remark:

In combination with **extension**
Ø 25 mm, reduced diameter to
penetrate into cavities / Powder cloud
like NF20



[Back to overview](#)

Flat jet nozzle / NF

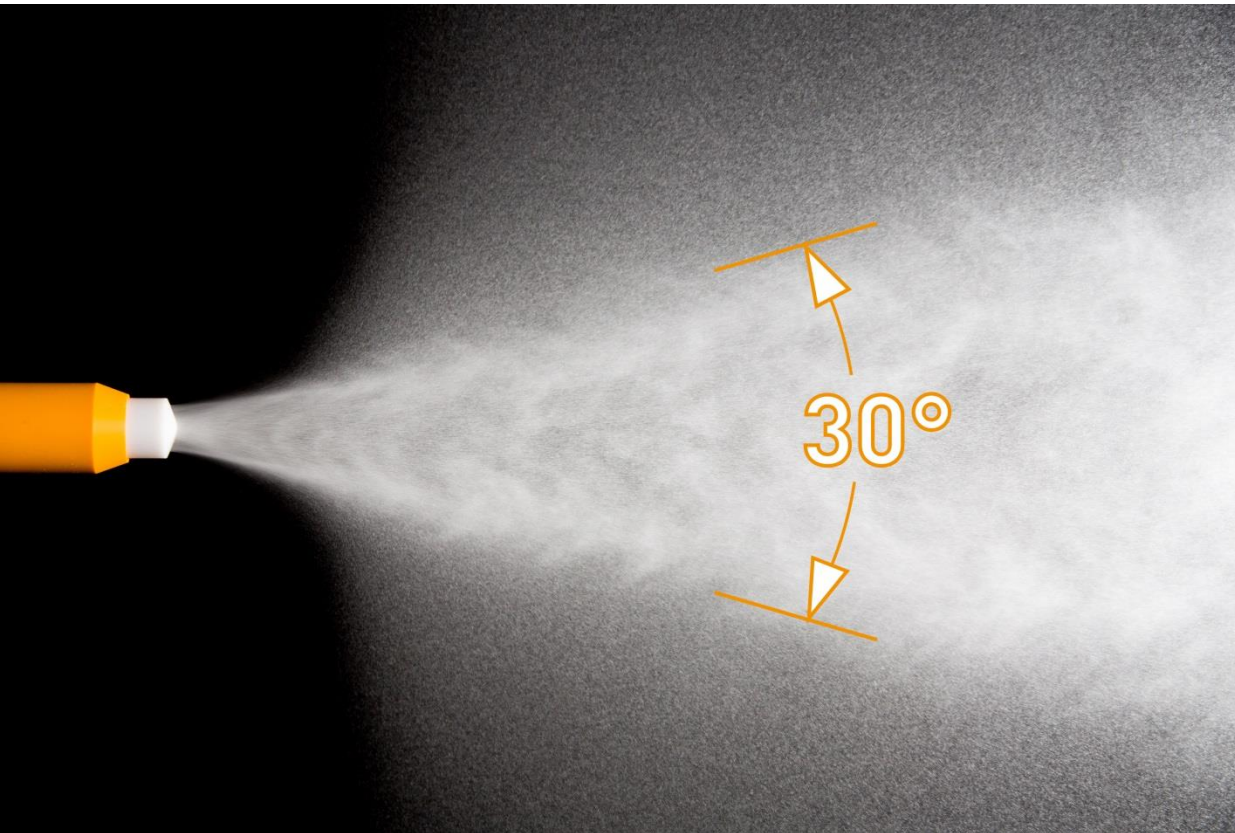

Flat jet nozzle type **NF26** (mini)

NF26 complete *with* electrode holder
Gema No. 1'007'744

NF26 *without* electrode holder
Gema No. 1'007'742

Field of application

- Automatic & manual nozzle
- Complex parts (deep recess)
 - Target spraying
 - Robot applications

Angle = **30°**

Velocity = **high**

Distance to object maximal = **450 mm**



[Back to overview](#)

Remark:

In combination with **extension Ø 25 mm**, reduced diameter to penetrate into cavities / Powder cloud like NF22

Flat jet nozzle / NF

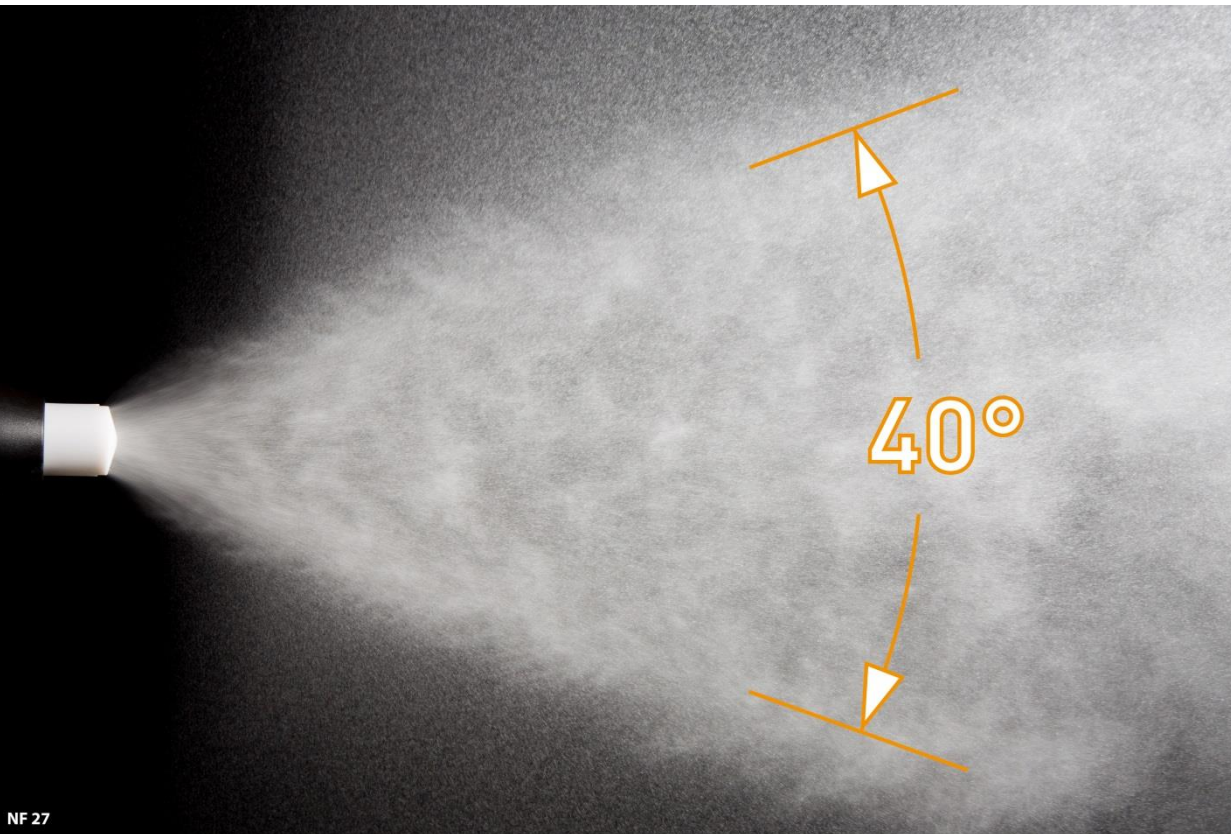

Flat jet nozzle type NF27
Standard for GA03

NF27 *complete with electrode holder*
Gema No. 1'010'754

NF27 *without electrode holder*
Gema No. 1'010'752

Field of application

Standard automatic nozzle

- Profiles
- Complex parts,
- Flat parts

Angle = **40°**

Velocity = **high - moderate**

Distance to object maximal = **350 mm**

Remark:

Alternative for large flat objects or complex parts, when nozzle close to the object = NF24



Back to overview

Round jet nozzle / NS

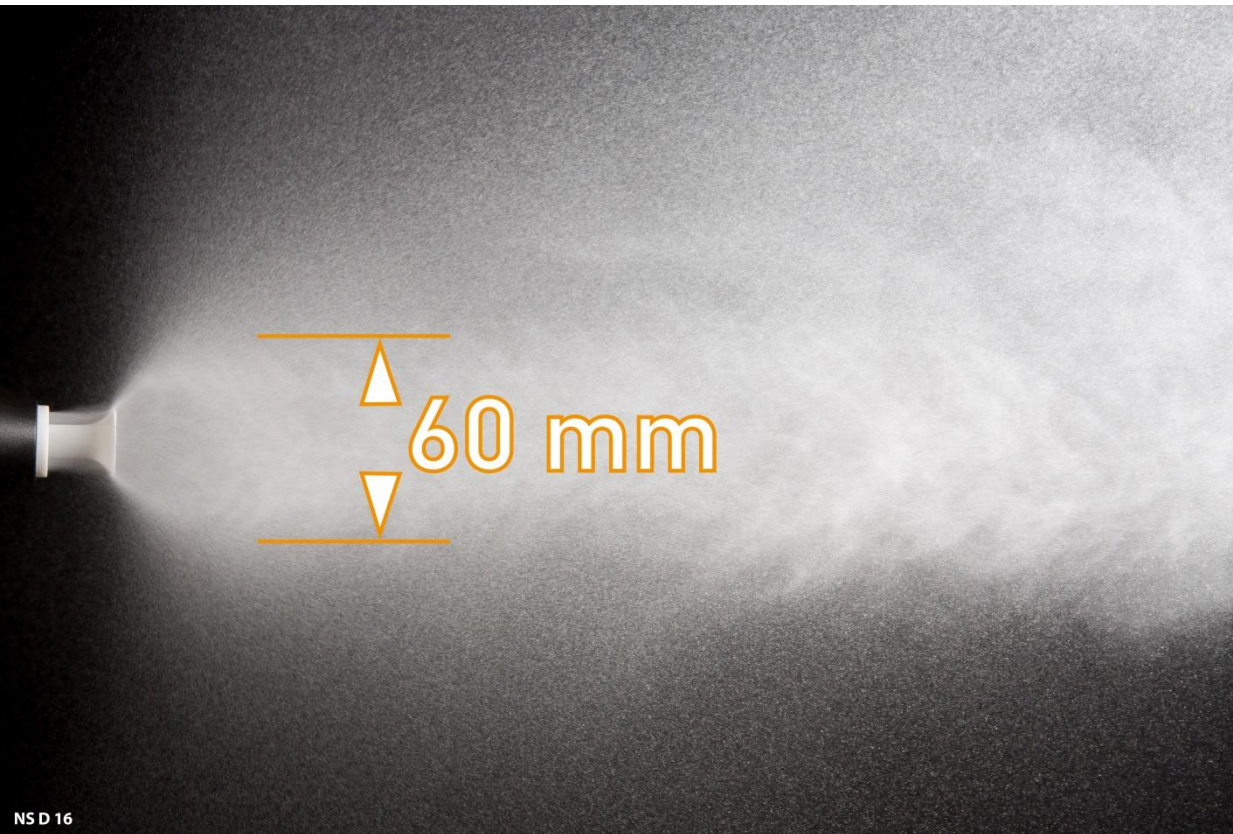

Round spray nozzle type NS

NS09 complete electrode holder
Gema No. 1'008'259

+

Deflector Ø16 mm
Gema No. 331'341

Field of application

Automatic & manual nozzle

- Flat parts
- Low speed coating
- Powder cloud 60mm

$\varnothing_{\text{maximal}}$ Powder cloud = **60 mm**

Velocity = **low**

Distance to object maximal = **120 mm**



[Back to overview](#)

Round jet nozzle / NS

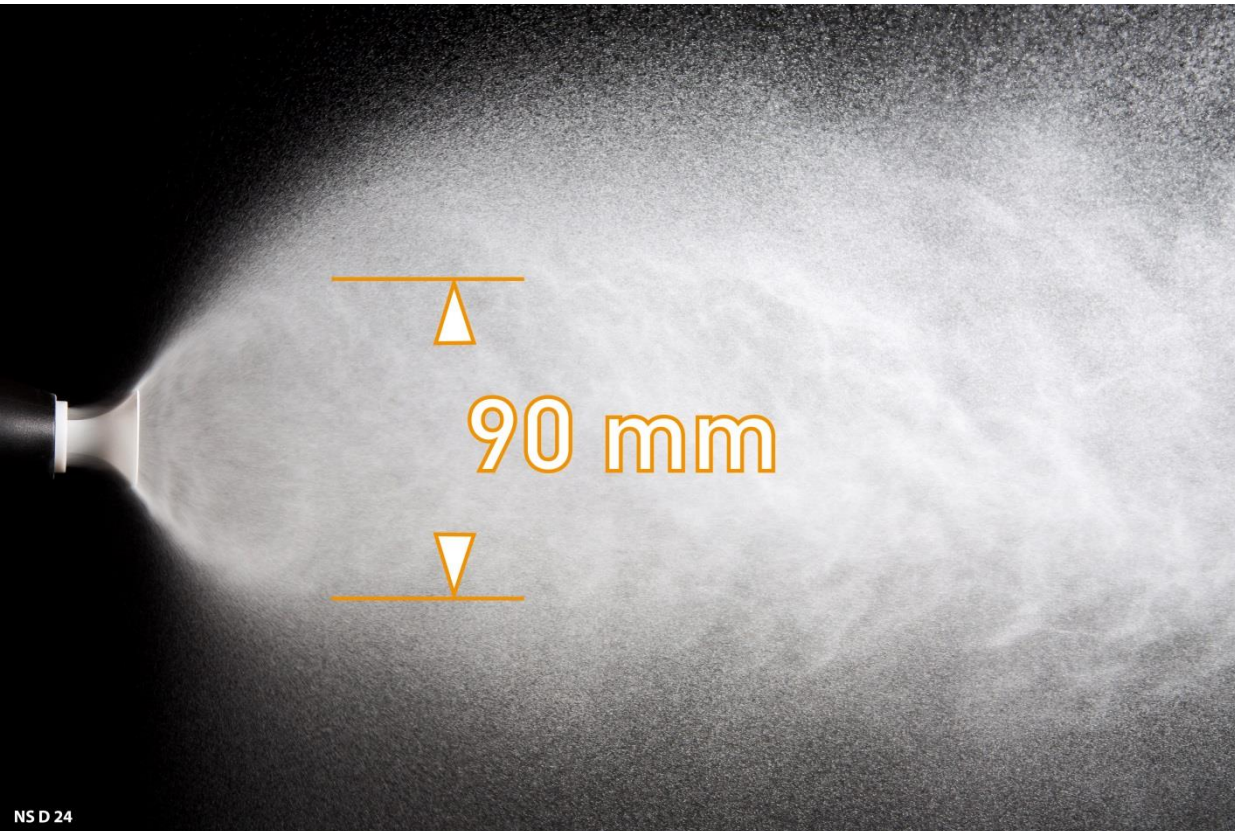

Round spray nozzle type NS

NS09 complete electrode holder
Gema No. 1'008'259

+

Deflector Ø24 mm
Gema No. 331'333

Field of application

Automatic & manual nozzle

- Flat parts
- Low speed coating
- Powder cloud 90mm

$\varnothing_{\text{maximal}}$ Powder cloud = **90 mm**

Velocity = **low**

Distance to object maximal = **160 mm**



[Back to overview](#)

Round jet nozzle / NS

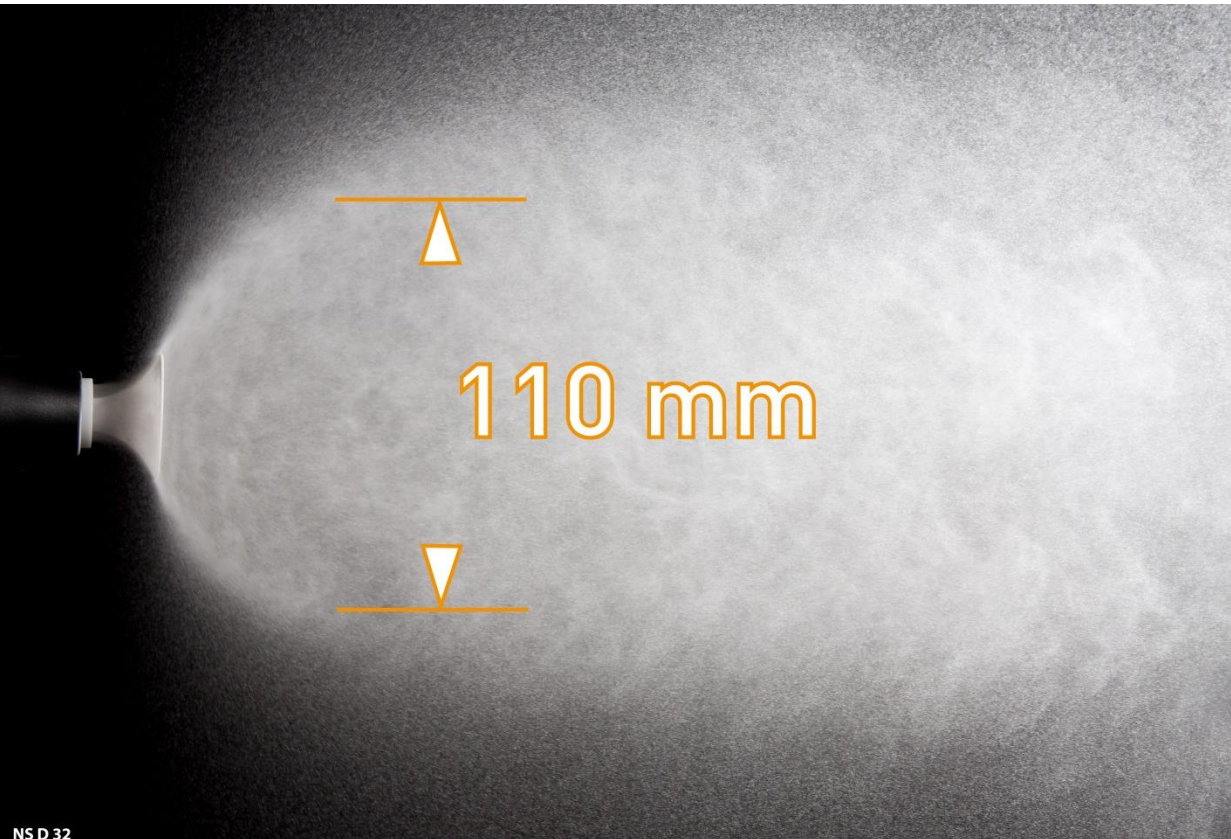

Round spray nozzle type NS

NS09 complete electrode holder
Gema No. 1'008'259

+

Deflector Ø32 mm
Gema No. 331'325

Field of application

Automatic & manual nozzle

- Flat parts
- Low speed coating
- Powder cloud 110 mm

$\varnothing_{\text{maximal}}$ Powder cloud = **110 mm**

Velocity = **low**

Distance to object maximal = **160 mm**



[Back to overview](#)

Round jet nozzle / NS

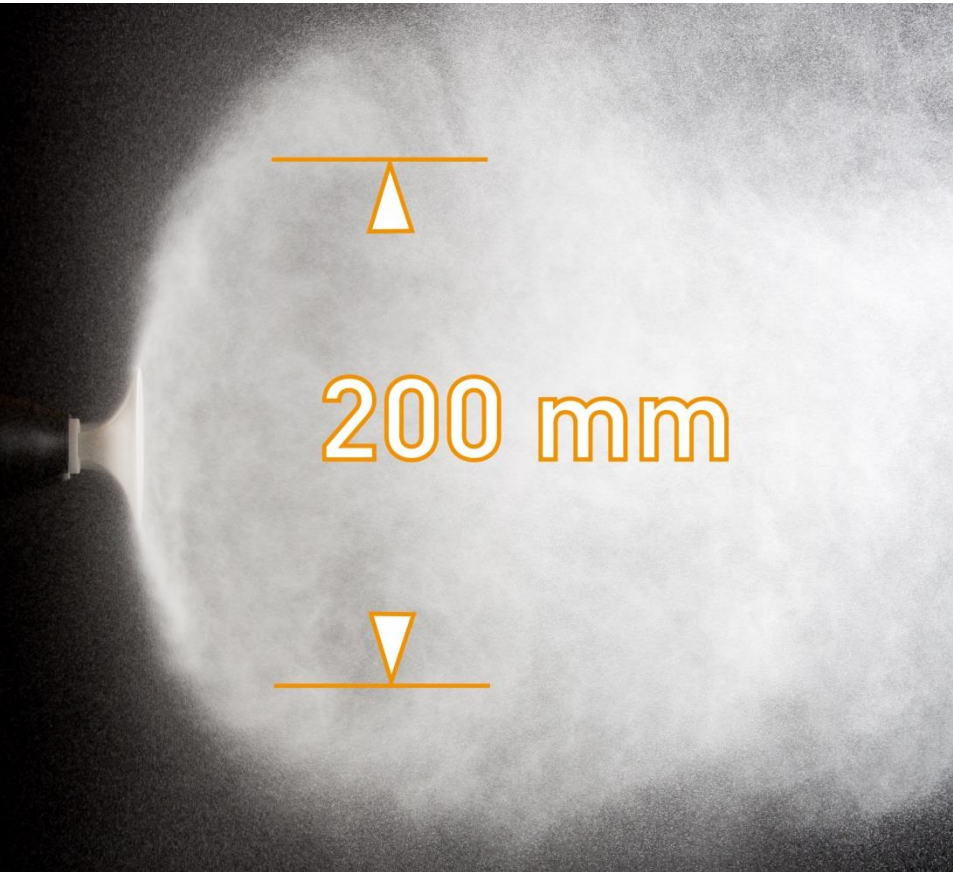

Round spray nozzle type NS

NS09 complete electrode holder

Gema No. 1'008'259

+

Deflector Ø50 mm

Gema No. 345'822

Field of application

Automatic & manual nozzle

- Flat parts
- Low speed coating
- Powder cloud 200 mm

$\varnothing_{\text{maximal}}$ Powder cloud = **200 mm**

Velocity = **low**

Distance to object maximal = **180 mm**



[Back to overview](#)

Comparison

NF 20 standard for manual $\alpha = 50^\circ$

NF 27 standard for automatic $\alpha = 40^\circ$

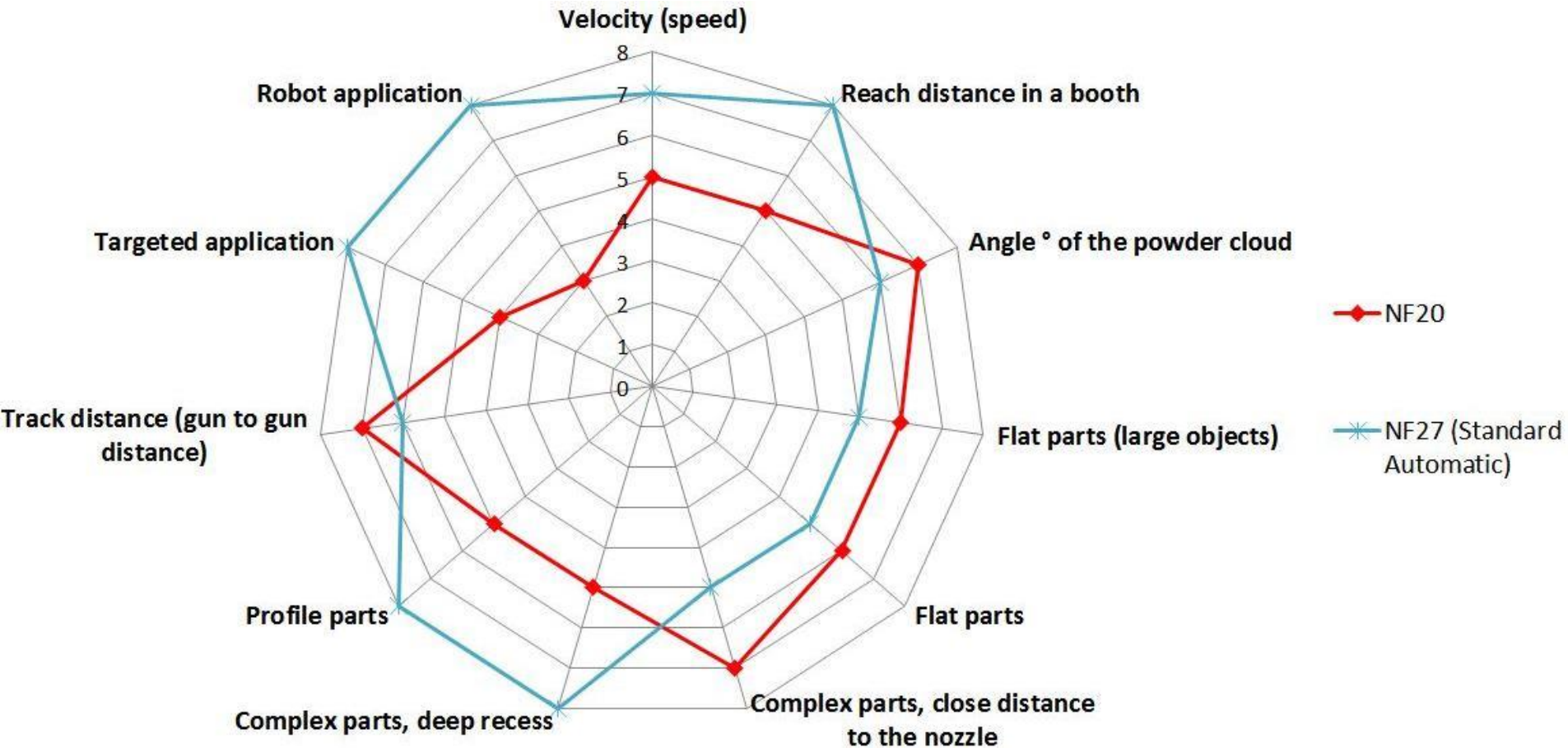







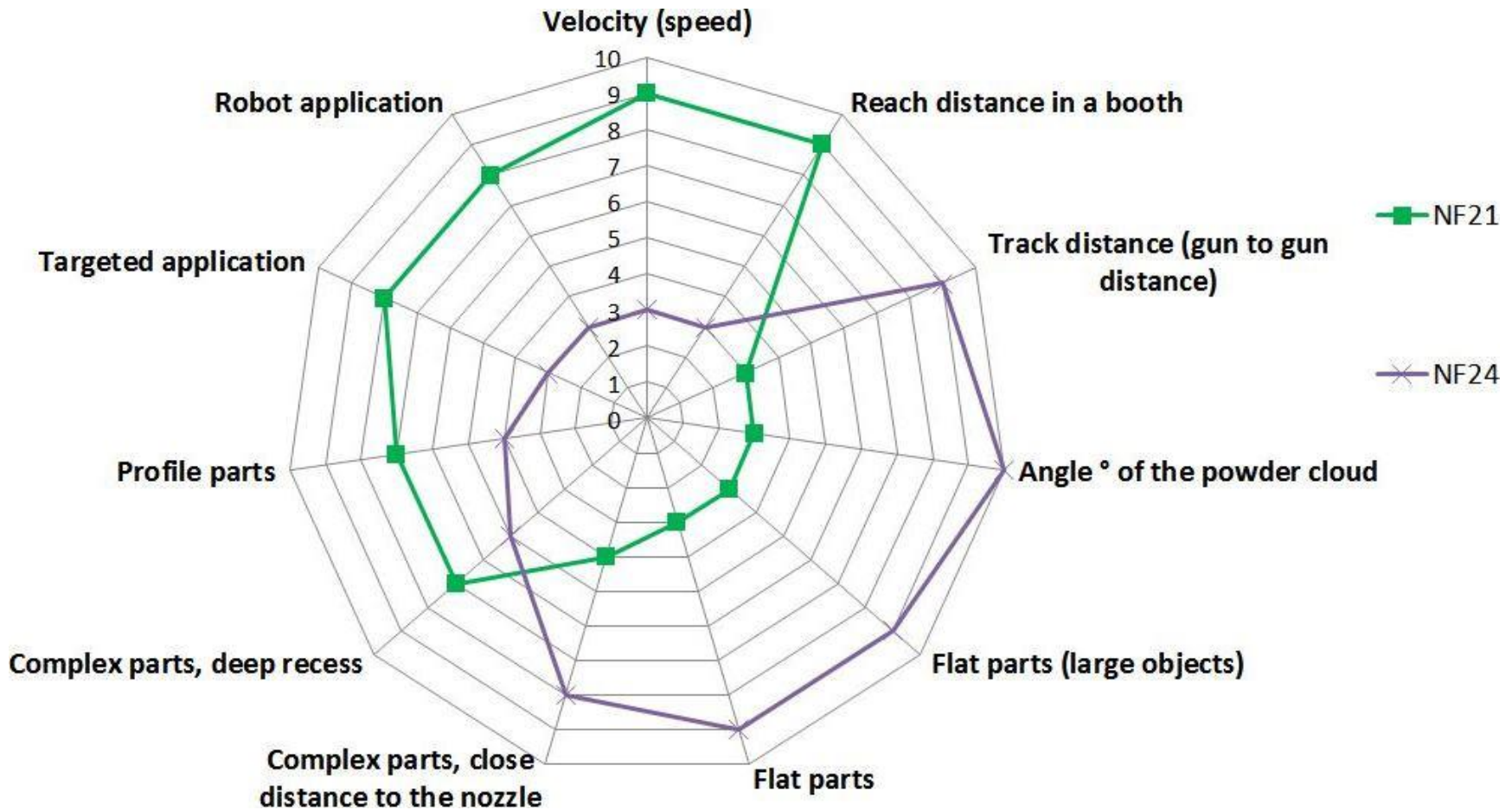

Comparison

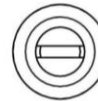
NF 21 $\alpha = 30^\circ$

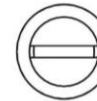
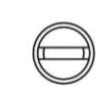
NF 24 $\alpha = 65^\circ$

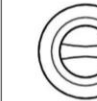

Nozzle Assortment overview

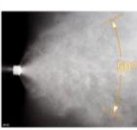
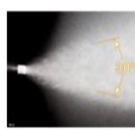
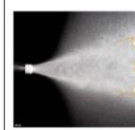
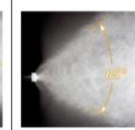
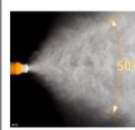
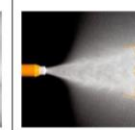
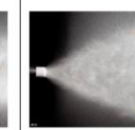
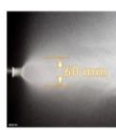
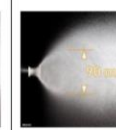
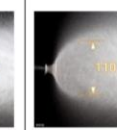
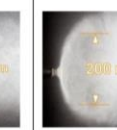
Nozzle type	NF20	NF21	NF22	NF24	NF25	NF26	NF27	Deflector Ø 16 mm	Deflector Ø 24 mm	Deflector Ø 32 mm	Deflector Ø 50 mm	
Gema No. with electrode holder	1'010'160	1'007'932	1'008'140	1'008'142	1'007'743	1'007'744	1'010'754	1'008'259 +	1'008'259 +	1'008'259 +	1'008'259 +	
Gema No. without electrode holder (Nozzle only)	1'010'090	1'007'935	1'008'145	1'008'147	1'007'735	1'007'742	1'010'752	331 341	331 333	331 325	345 822	
												
Powder cloud												
Standard scope of delivery	Manual application Standard							Automatic application Standard				
Application	Flat parts, profiles, manual applications	Complex parts deep recess, target spraying	Complex parts deep recess, target spraying, robot applications	Large objects, flat parts, manual applications, complex parts, when nozzle close to the object	Flat parts, profiles, manual applications	Complex parts deep recess, target spraying, robot applications	Profiles, complex parts, flat parts (Limitation: NF27 requires a minimal clearance between object and nozzle)					
Powder cloud α° Powder cloud Ø	50°	30°	30°	65°	50°	30°	40°	Ø 60 mm	Ø 90 mm	Ø 110 mm	Ø 200 mm	
Velocity Air setting @ [4 Nm ³ /h]	moderate - low	high	high	low	moderate - low	high	high - moderate	low	low	low	low	
Reach distance maximal automatic application Air settings @ [4 Nm ³ /h]	250 mm	400 mm	450 mm	200 mm	250 mm	450 mm	350 mm	120 mm	160 mm	160 mm	180 mm	
Remark				In combination with threaded sleeve Gema Nr. 1'008'326	In combination with extension Ø 25mm, reduced diameter to penetrate into cavities Powder cloud like NF20	In combination with extension Ø 25mm, reduced diameter to penetrate into cavities Powder cloud like NF22						